

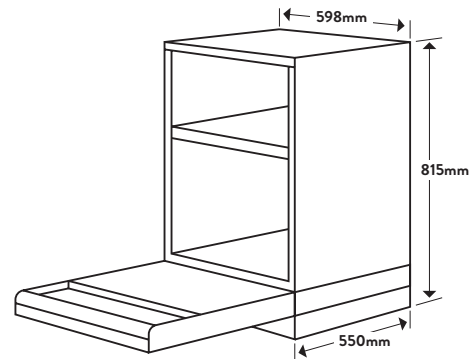

Dimensions/Weight

Overall Dimensions (mm): 815(h) x 598(w) x 550(d)
Weight: 43kg



Technical Details

Style

Dishwasher Type: Fully Integrated
Category Size: 60cm

Functionality

Place Settings: 14
Wash Programs: Intensive
Heavy
Normal
Glass
90 min
Quick
Water Rating: 4.5 Stars
Energy Rating: 3 Stars
Wash Temperatures (°C): 4 - 40, 50, 55 and 65°C
Maximum Water Temperature (°C): 60°C
Floating Plug: Yes
Lockable Controls: No
Delayed Start: Yes (1-24 Hours)
Dual Zone: No
AquaStop Safety Hose: No
Flexible Top Basket: Yes
Cutlery Tray: No
Half Load: Yes
Allowable Plate Size: Up to 30cm
Residual Heat Drying: Yes

Installation

Maximum Current: 10amps
Connection: 240V, 50Hz
Water Connection: Cold Water Recommended
Length of Hose: 2.0m
Water Pressure: 40 - 1000kpa
Noise: 49dBA
Warranty: 24 Months Parts and Labour

Customer Care

T: 1300 739 033 (AU) 09 415 6000 (NZ)
E: customercare@omegaappliances.com.au customercare@monacocorp.co.nz
Updated 30/01/2020 - V1

Aesthetics

Finish: Supplied Without a Decorative Door
Controls: Electronic Controls Hidden in the Top of the Door

Key Features



Half Load

Half Load is for a reduced load using less energy and water.



Flexible Basket

Every load is different. That's why we've designed a Flexible Basket option which allows you to adapt the interior and fit dishes of all shapes and sizes - anywhere. The simple pull out height adjustable basket will allow you to make the most of your dishwasher.

NB: Drawings are not to scale - they are to assist only.
WARNING: technical specifications and product sizes can be varied by the manufacturer without notice. Cutouts for appliances should only be by physical product measurements. The above information is indicative only.