omega

Instructions for the Use and Care and Installation of

ORW6XA

ORW9XA

ORC92X

Wall Canopy Rangehoods

CONTENTS

1	Notice
2	Features
3	Installation
4	Notice of installation
5	Safety Warning
6	Use Instructions
7	Maintenance
8	Troubleshooting
9	Specification

It is important that you retain these instructions, proof of purchase as well as other important documents about this product for future reference.

Due to continual product development, Omega reserves the right to alter specifications or appearances without notice.

Dispose of packaging responsibly – recycle where facilities are available.

(1) NOTICE

1. Thank you for choosing our cooker hood. Please read the instruction manual carefully before use.
2. The installation work must be undertaken by a qualified electrician and competent installer.
3. The manufacturer disclaims all liability for any damage or injury caused as a result of not following instructions for installation contained in the following text.

The cooker hood is rated for use on 220/240V, 50Hz.

(2) FEATURES

- 1.** The cooker hood uses high quality materials, and is made with a streamlined design.
- 2.** Equipped with a high power electric motor and centrifugal fan, it produces strong suction with low noise, and features a non stick grease filter which is easy to clean.
- 3.** The isolated low voltage (12 volt) circuit board control, means the halogen lights are brighter and safer than incandescent alternatives.
- 4.** Due to the special wind tunnel construction and filter design, any odours and dust will be absorbed quickly.

(3) INSTALLATION

3.1 The cooker hood should be placed at a distance of 65-75cm (26-30inch) from the cooking surface for the best effect. See Pic 1.

3.2 Install the hook in a suitable place once the installation height is fixed, and keep it vertically aligned. The fixed position of the inside chimney bracket determines the location of the chimney.

3.3 Fix the outside chimney bracket on the outside chimney, and be sure that the inside chimney can be adjusted in height freely, as well as being able to fix the exhaust pipe. Afterwards, install the exhaust pipe and chimney on the cooker hood. See Pic 3.

3.4 Lift the cooker hood onto the hook. See Pic 4.

3.5 Adjust the height of the inside chimney to the position of the inside chimney bracket, and fix by screw. After adjusting the position, fix the body with safety screws. See Pic 5.

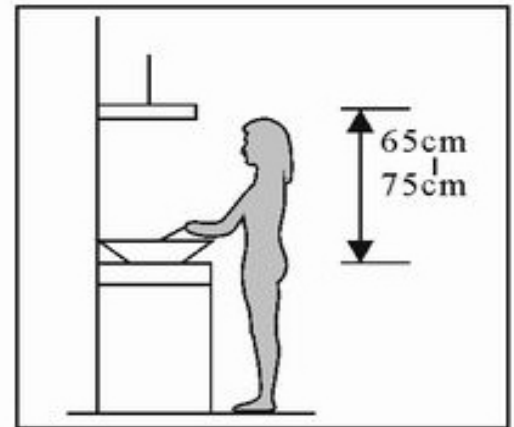

Pic1

Note: The two safety screw holes are positioned on the back casing, with diameter of 6mm.

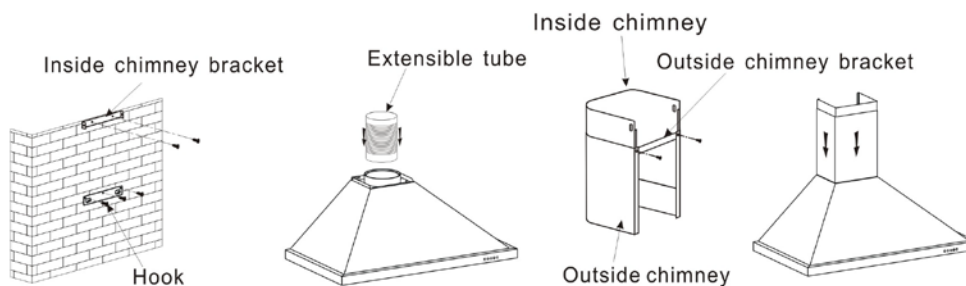

Pic2

Pic3

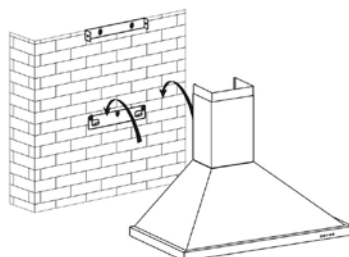

Pic4

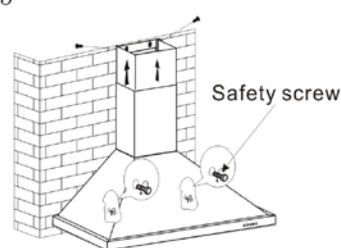

Pic5

(4) NOTICE OF INSTALLATION

1. Before installation, please ensure the area is clean, to avoid suction of the remaining bits of broken wood and dust.
2. The canopy hood cannot share the same air ventilation ducting as other appliances, such as gas and electric heaters.
3. The bending of the ventilation ducting should be $\geq 120^\circ$, parallel or above the exit vent, and should be connected through the external wall.
4. After installation, make sure that the extractor is level to avoid grease collection at one end.

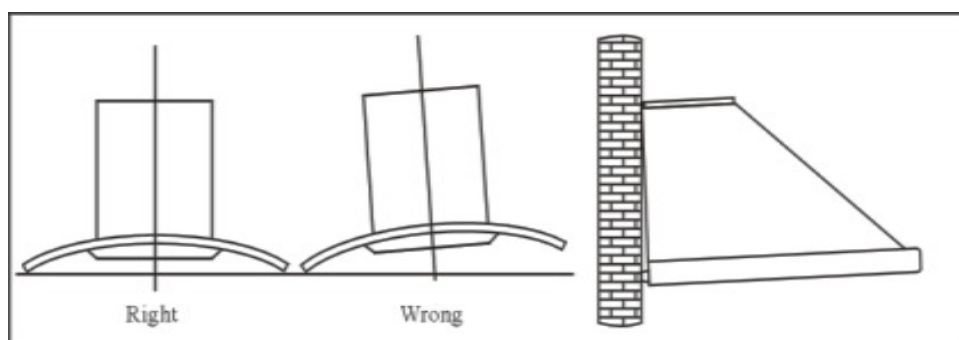

Pic5

NOTE: Remove all protective plastic coatings from the stainless steel surfaces before use.

(5) SAFETY WARNING

- ✧ Young children should be supervised to ensure that they do not play with the appliance.
- ✧ The appliance is not intended for use by persons (including children) with reduced physical, sensory or mental capabilities, or lack of experience and knowledge, unless they have been given supervised or instruction concerning use of the appliance by a responsible person for their safety.
- ✧ Your cooker hood is for domestic use only, not suitable for barbecue, fast - food shops, and other commercial use.
- ✧ Any installation work must be carried out by a qualified electrician or competent person.
- ✧ The cooker hood and its filter mesh should be cleaned regularly in order to keep in good working order.
- ✧ Before cleaning, always ensure that you have switched your cooker hood off.
- ✧ Do not flambé under the range hood.
- ✧ Clean the cooker hood according to the instruction manual, and keep the cooker hood away from the danger of flames.
- ✧ If there is any fault with your cooker hood, please call the customer service number in the Warranty Card.
- ✧ Please keep the room adequately ventilated when your cooker hood and gas hob are working.
- ✧ Do not exhaust the gas from cooker hood through the same heated flue which is for the gas from gas hob and other kitchen appliances.
- ✧ Before installation and usage, read all the instructions and make sure that the voltage (V) and the frequency (Hz) indicated on your cooker hood are exactly the same as the voltage (V) and the frequency (Hz) in your home.
- ✧ To ensure that you get the best Warranty experience for your cooker hood, please provide copies of the Warranty Card and purchase receipt, when booking warranty work with the Customer Service department.

(6) USE INSTRUCTIONS

The re-usable aluminium grease filters supplied with this rangehood should be cleaned every month or so to avoid grease build-up.

To remove the grease filter, release the locking mechanism at the front of the filter, and lower the filter slightly to unhook it at the back. Whilst the filter is removed, clean off any residual grease from the housing to avoid fire risk.

When replacing the grease filters, ensure that the locking mechanism is facing down.

If the rangehood is used in re-circulation mode, the activated charcoal filter must be in place. These charcoal filters are designed to absorb cooking odours and are located in the canopy above the grease filters. Before fitting or replacing charcoal filters, the grease filters must first be removed.

To remove, or install, the charcoal filter - twist the charcoal filter in the direction shown below.

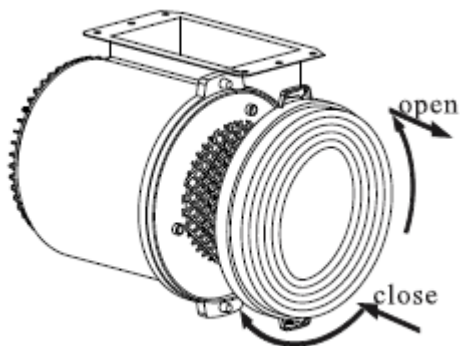

SPEED ADJUSTMENT - See pictures

1. Push 'Stop' button, and the motor will stop.
2. Push the 'Low' button, the motor runs at low speed.
3. Push the 'Mid' button, the motor runs at mid speed.
4. Push the 'High' button, the motor runs at high speed.
5. Push the 'Light' button and the two lights will be on. Push it again and the light will be off.

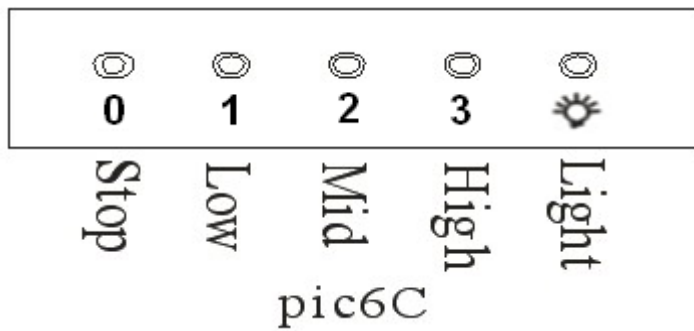

(7) MAINTENANCE

7.1 Cleaning the grease filter mesh

The filter mesh is made of high-density stainless steel. Please do not use corrosive detergent on it. Keeping this filter clean will keep the appliance running correctly. Please strictly follow the guidelines below.

Method 1: Place the mesh in 40 - 50 DegC clean water, add in a small amount of detergent, and soak for 2 - 3 minutes. Wear gloves, and clean with a soft brush. Do not apply too much pressure, as the mesh is delicate and will damage easily.

Method 2: The grease filters can be put into a dishwasher. To do so, set the temperature at around 60 degrees.

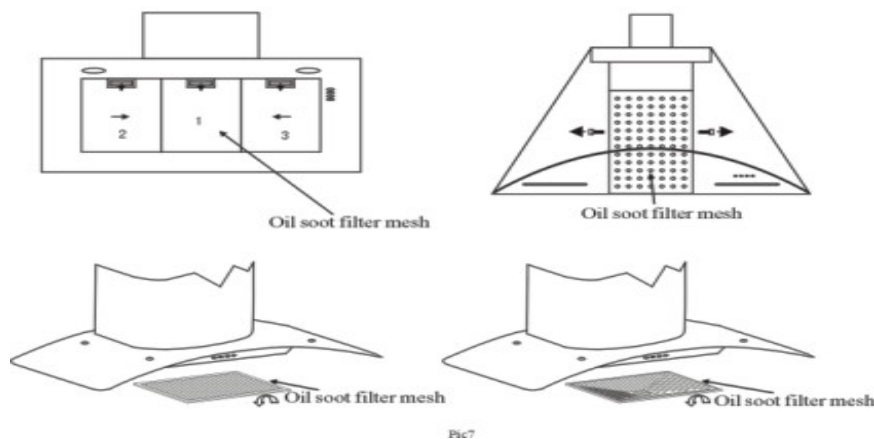

7.2 Notice of cleaning cooker hood

- A. To protect the main body from corrosion over a long period of time, the cooker hood should be cleaned with hot water plus non corrosive detergent every two months.
- B. Please do not use abrasive detergent for it will damage the body.
- C. Keep the motor and other spare parts free from water, as this will cause damage to the appliance.
- D. Before cleaning the appliance please remember to turn off power
- E. If fitted with active charcoal filters, the charcoal filter should not be exposed to heat.
- F. Please do not tear open the fixed bar around the active charcoal filter.
- G. If the supply cord is damaged, it must be replaced by the manufacturer or its service agent or a similarly qualified person in order to avoid a hazard.

(8) TROUBLESHOOTING

Fault	Cause	Solution
Light on, but motor does not work	The fan is blocked	Remove the source of the blockage
	The capacitor damaged	Replace capacitor
	The motor jammed and bearing damaged	Replace motor
	A smell coming from the motor	Replace motor
Light does not work, motor does not work	Beside the above mentioned, check the following:	
	Light damaged	Replace lights
	Power cord loose	Take to authorised service centre.
Oil leakage	One way valve and the air ventilation entrance are not tightly sealed	Take down the one way valve and seal with silicon rubber.
	Leakage from the connection of U-shaped section and cover	Take U-shaped section down and seal with silicon or paint
Shake of the body	The fan is damaged and causes shaking	Replace the fan
	The motor is not tightly mounted	Lock the motor mounts tightly
	The body is not tightly hung on wall	Fix the body tightly
Insufficient suction	The distance between the body and the gas top too long	Readjust the distance
	Too much ventilation or breeze from open doors or windows	Choose a better location and re-assemble the machine
The machine inclines	The fixing screw not tight enough	Tighten the hanging screw and make it horizontal
	The hanging screw not tight enough	Tighten the hanging screw and make it horizontal

(9) SPECIFICATION

Model	ORW6XA /ORW9XA
Rated Input	220V-240V, 50Hz
Rated Power	230W
Lighting Power	20W X 2 (halogen capsule lamp)
Motor Power	190W
Air tube diameter	150MM
Air output	700m ³ /h

Model	ORC92X
Rated Input	220V-240V, 50Hz
Rated Power	272W
Lighting Power	7W X 1 (LED strip)
Motor Power	265W
Air tube diameter	150MM
Air output	1000m ³ /h

