



**omega**

Instruction Manual

MICROWAVE OVEN/GRILL

---

Model OMOG25B /

OMOG25S /

OMOG25W

# Thank you for purchasing an Omega appliance

Tailored for the modern aesthetic and lifestyle of busy people, your new Omega Appliance will make a welcome addition to the family.

Omega caters to style-savvy customers who look for balance between stunning form and clever function. This means a combination of sleek, chic, sophisticated design yet effortless functionality. And we source from the best. The best craftsmanship. The best innovation. From the best international design-houses.

All brought together under an appliance that stands for design-led balance.

Please take the time to read through the following instruction manual to familiarise yourself with the installation, operation requirements and maintenance to ensure optimum performance.

## Further Information

For important information about your Omega Appliance such as warranty registration, manuals, features, and specifications please visit [omegaappliances.com.au](http://omegaappliances.com.au) (if you are in Australia) and [omegaappliances.co.nz](http://omegaappliances.co.nz) (if you are in New Zealand) or contact our Customer Care team on the below email or phone numbers.

## Registering Your Warranty

For peace of mind you can register your warranty at [omegaappliances.com.au](http://omegaappliances.com.au). Further information on the Warranty can be found at the end of this manual.

## Contact Us

Our customer service team is here to help you with any question or concern. Both teams are on call Monday to Friday 8.30am to 5.00pm and of course you can always send an email at your convenience.

### Australia Contact Details

Monday to Friday 8.30am – 5.00pm  
Email: [customercare@omegaappliances.com.au](mailto:customercare@omegaappliances.com.au)  
Phone: 1300 739 033

### New Zealand Contact Details

Monday to Friday 8.30am – 5.00pm  
Email: [customercare@monacocorp.co.nz](mailto:customercare@monacocorp.co.nz)  
Phone: 09 415 6000

To stay up to date and find simple and easy recipes, follow us on our socials:

[facebook.com/omegaappliances](https://facebook.com/omegaappliances)  
[instagram.com/omegaappliances\\_au](https://instagram.com/omegaappliances_au)

## READ THE INSTRUCTION BOOKLET BEFORE INSTALLING AND USING THE APPLIANCE.

It is important that you retain these instructions, proof of purchase as well as other important documents about this product for future reference.

The manufacturer will not be responsible for any damage to property or to persons caused by incorrect installation or improper use of the appliance.

*Due to continual product development, Omega reserves the right to alter specifications and appearances without notice.*

## Contents

---

IMPORTANT SAFETY WARNINGS.....	1
UTENSILS IN THE MICROWAVE .....	3
PRODUCT DETAILS.....	4
SETTING UP YOUR OVEN .....	4
INSTALLATION .....	5
OPERATING INSTRUCTIONS .....	6
MAINTENANCE AND CLEANING .....	10
TROUBLESHOOTING .....	10
WARRANTY.....	11

## Disposal Information

---

- Most of the packaging materials are recyclable. Please dispose of these materials through your local recycling depot or by placing them into appropriate collection containers.
- If you wish to discard this product, please contact your local authorities and ask for the correct method of disposal.

# Important Safety Warnings

---

## READ CAREFULLY AND KEEP FOR FUTURE REFERENCE.

To reduce the risk of fire, electric shock, injury to persons or exposure to excessive microwave oven energy when using your appliance, follow basic precautions, including the following:

1. **WARNING:** Liquids and other foods must not be heated in sealed containers since they are liable to explode.
2. **WARNING:** It is hazardous for anyone other than a competent person to carry out any service or repair operation that involves the removal of a cover which gives protection against exposure to microwave energy.
3. The appliance is not intended for use by persons (including children) with reduced physical, sensory or mental capabilities, or lack of experience and knowledge, unless they have been given supervised or instruction concerning use of the appliance by a responsible person for their safety.
4. Keep the appliance and its cord out of reach of children.
5. Only use utensils suitable for use in microwave ovens.
6. When heating food in plastic or paper containers, keep an eye on the oven due to the possibility of ignition.
7. If smoke is emitted, switch off or unplug the appliance and keep the door closed in order to stifle any flames.
8. Do not use the oven cavity for storage purposes. Do not store items, such as bread, cookies, etc. inside the oven.
9. Remove wire twist-ties and metal handles from paper or plastic containers/bags before placing them in the oven.
10. Install or locate this oven only in accordance with the installation instructions provided.
11. Eggs in the shell and whole hard-boiled eggs should not be heated in microwave ovens since they may explode, even after microwave heating has ended.
12. This appliance is intended to be used in household and similar applications such as:
  - staff kitchen areas in shops, offices and other working environments;
  - by clients in hotels, motels and other residential type environments;
  - farm houses;
  - bed and breakfast type environments.
13. If the supply cord is damaged, it must be replaced by the manufacturer, its service agent or similarly qualified persons in order to avoid a hazard.
14. Do not store or use this appliance outdoors.
15. Do not use this oven near water, in a wet basement or near a swimming pool.
16. The temperature of accessible surfaces may be high when the appliance is operating. The surfaces are liable to get hot during use. Keep cord away from heated surface, and do not cover any vents on the oven.
17. Do not let cord hang over edge of table or counter.
18. The contents of feeding bottles and baby food jars shall be stirred or shaken and the temperature checked before consumption, in order to avoid burns.
19. Microwave heating of beverages can result in delayed eruptive boiling. Therefore, care must be taken when handling the container.
20. Young children should be supervised to ensure that they do not play with the appliance.
21. The appliances are not intended to be operated by means of an external timer or separate remote-control system.
22. Accessible parts may become hot during use. Young children should be kept away.
23. Steam cleaners are not to be used.
24. During use the appliance becomes hot. Care should be taken to avoid touching heating elements inside the oven.
25. **WARNING:** The appliance and its accessible parts become hot during use. Care should be taken to avoid touching heating elements. Children shall be kept away unless continuously supervised.

## Important Safety Warnings

---

26. The microwave oven must be operated with the decorative door open (for ovens with a decorative door.)
27. **WARNING:** Only allow children to use the oven without supervision when adequate instructions have been given so that the child is able to use the oven in a safe way and understands the hazards of improper use.
28. **WARNING:** It is hazardous for anyone other than a trained person to carry out any service or repair operation which involves the removal of any cover which gives protection against exposure to microwave energy.
29. Metallic containers for food and beverages are not allowed during microwave cooking. This requirement is not applicable if the manufacturer specifies size and shape of metallic containers suitable for microwave cooking.
30. The microwave oven is intended for heating food and beverages. Drying of food or clothing and heating of warning pads, slippers, sponges, damp cloth and similar may lead to risk of injury, ignition or life.
31. The oven should be cleaned regularly and any food deposits removed. The door frame, door seal, cavities and neighbouring parts must be cleaned carefully with a damp cloth when they are dirty.
32. Failure to maintain the oven in a clean condition could lead to deterioration of the surface that could adversely affect the life of the appliance and possibly result in a hazardous situation.
33. The microwave oven can be used freestanding or in a cabinet.
34. **WARNING:** Risk of Fire, do not install the product in cabinet smaller than cabinet size 613Wx476Dx457H mm. Minimum clearance of 15cm above the microwave oven, a minimum clearance of 5cm is required between the microwave oven and any adjacent walls.
35. The appliance must be operated with any cabinet door open.

### PRECAUTIONS TO AVOID POSSIBLE EXPOSURE TO EXCESSIVE MICROWAVE ENERGY

1. Do not attempt to operate this oven with the door open since this can result in harmful exposure to microwave energy. It is important not to break or tamper with the safety interlocks.
2. Do not place any object between the oven front face and the door or allow soil or cleaner residue to accumulate on sealing surfaces.
3. **WARNING:** If the door or door seals are damaged, the oven must not be operated until it has been repaired by a competent person.
4. If the apparatus is not maintained in a good state of cleanliness, its surface could be degraded and affect the lifespan of the apparatus and lead to a dangerous situation.

### DANGER: Electric Shock Hazard

Touching some of the internal components can cause serious personal injury or death. Do not disassemble this appliance.

### WARNING:

A short power-supply cord is provided to reduce the risks resulting from becoming entangled in or tripping over a longer cord.

If a long cord set or extension cord is used:

- The marked electrical rating of the cord set or extension cord should be at least as great as the electrical rating of the appliance.
- The long cord should be arranged so that it will not drape over the counter top or tabletop where it can be pulled on by children or tripped over unintentionally.

## UTENSILS IN THE MICROWAVE

### MATERIALS TO BE AVOIDED IN THE MICROWAVE OVEN

Utensils	Remarks
Aluminum tray	May cause arcing. Transfer food into microwave-safe dish.
Food carton with metal handle	May cause arcing. Transfer food into microwave-safe dish.
Metal or metal trimmed utensils	Metal shields the food from microwave energy. Metal trim may cause arcing.
Metal twist ties	May cause arcing and could cause a fire in the oven.
Paper bags	May cause a fire in the oven.
Plastic foam	Plastic foam may melt or contaminate the liquid inside when exposed to high temperature.
Wood	Wood will dry out when used in the microwave oven and may split or crack.

### Utensil Test

1. Fill a microwave-safe container with 1 cup of cold water (250ml) along with the utensil in question.
2. Cook on maximum power for 1 minute.
3. Carefully feel the utensil. If the empty utensil is warm, do not use it for microwave cooking.
4. **Do not exceed 1 minute cooking time.**

### MATERIALS YOU CAN USE IN THE MICROWAVE OVEN

Utensils	Remarks
Aluminium foil	Shielding only. Small smooth pieces can be used to cover thin parts of meat or poultry to prevent overcooking. Arcing can occur if foil is too close to oven walls. The foil should be at least 1 inch (2.5cm) away from oven walls.
Browning dish	Follow manufacturer's instructions. The bottom of browning dish must be at least 3/16 inch (5mm) above the turntable. Incorrect usage may cause the turntable to break.
Dinnerware	Microwave-safe only. Follow manufacturer's instructions. Do not use cracked or chipped dishes.
Glass jars	Always remove lid. Use only to heat food until just warm. Most glass jars are not heat resistant and may break.
Glassware	Heat-resistant oven glassware only. Make sure there is no metallic trim. Do not use cracked or chipped dishes.
Oven cooking bags	Follow manufacturer's instructions. Do not close with metal tie. Make slits to allow steam to escape.
Paper plates and cups	Use for short-term cooking/warming only. Do not leave oven unattended while cooking.
Paper towels	Use to cover food for reheating and absorbing fat. Use with supervision for a short-term cooking only.
Parchment paper	Use as a cover to prevent splattering or a wrap for steaming.
Plastic	Microwave-safe only. Follow the manufacturer's instructions. Should be labeled "Microwave Safe". Some plastic containers soften, as the food inside gets hot. "Boiling bags" and tightly closed plastic bags should be slit, pierced or vented as directed by package.
Plastic wrap	Microwave-safe only. Use to cover food during cooking to retain moisture. Do not allow plastic wrap to touch food.
Thermometers	Microwave-safe only (meat and candy thermometers).
Wax paper	Use as a cover to prevent splattering and retain moisture.

# PRODUCT DETAILS

<b>Model:</b>	OMOG25B, OMOG25S, OMOG25W
<b>Rated Voltage:</b>	230-240V~ 50Hz
<b>Rated Input Power (Microwave):</b>	1450W
<b>Rated Output Power (Microwave):</b>	900W
<b>Oven Capacity:</b>	25L
<b>Rated Input (Grill)</b>	1000W
<b>Turntable Diameter:</b>	315 mm
<b>External Dimensions (WxDxH):</b>	513x410x307mm
<b>Net Weight:</b>	Approx. 14.8kg

## SETTING UP YOUR OVEN

### Names of Microwave Oven Parts and Accessories

Remove the microwave oven and all materials from the carton and oven cavity. Your oven comes with the following accessories:

- A) Control Panel
- B) Turntable Shaft
- C) Turntable Ring Assembly
- D) Glass Tray
- E) Observation Window
- F) Door Assembly
- G) Safety Interlock System



Grill Rack( Only be used in grill function and be placed on the glass tray )

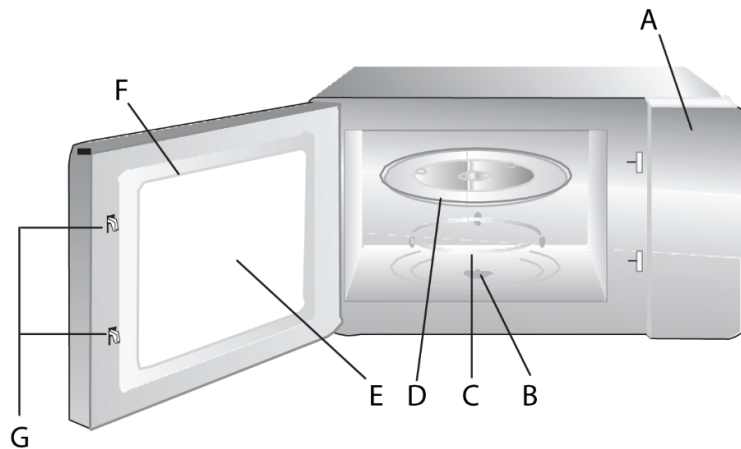

### Turntable Installation

1. Never place the glass tray upside down. The glass tray should never be restricted.
2. Both glass tray and turntable ring assembly must always be used during cooking.
3. All food and containers of food are always placed on the glass tray for cooking.
4. If glass tray or turntable ring assembly cracks or breaks, contact your nearest authorized service center.

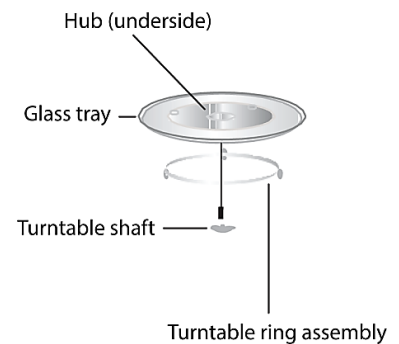

# INSTALLATION

---

## Before Installation

Remove all packing material and accessories. Examine the microwave oven for any damage such as dents or broken door. Do not install if oven is damaged.

**Do not remove the light brown Mica cover that is attached to the oven cavity to protect the magnetron.**

## Freestanding Installation

Select a level surface that provides enough open space for the intake and/or outlet vents.

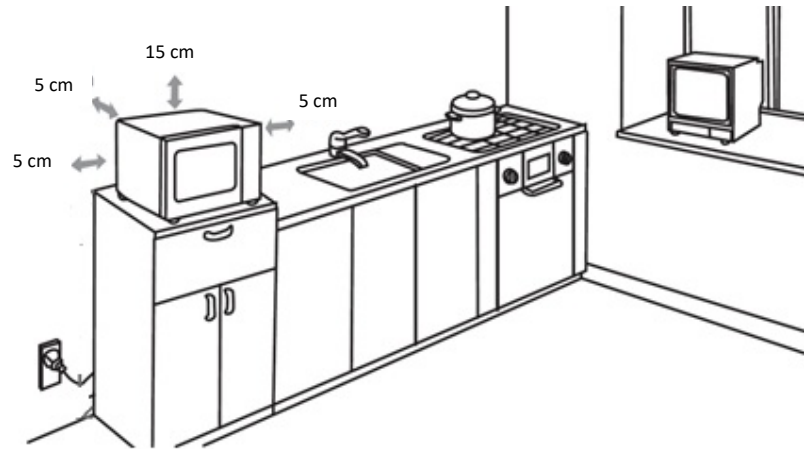

1. The rear surface of appliance shall be placed against a wall.
2. Leave a minimum clearance of 15cm above the microwave oven, a minimum clearance of 5cm is required between the microwave oven and any adjacent walls.
3. Do not remove the legs from the bottom of the oven.
4. Blocking the intake and/or outlet openings can damage the microwave oven.
5. Place the oven as far away from radios and TVs as possible. Operation of microwave oven may cause interference to your radio or TV reception.
6. Plug your oven into a standard household outlet. Be sure the voltage and the frequency is the same as the voltage and the frequency on the rating label.

**WARNING:** Do not install oven over a range cooktop or other heat-producing appliance. If installed near or over a heat source, the oven could be damaged and the warranty would be void.

## Cabinet Installation

Minimum clearance of 15cm above the microwave oven, a minimum clearance of 5cm is required between the microwave oven and any adjacent walls.

**WARNING:** Risk of Fire, do not installation the product in cabinet smaller than cabinet size 613Wx476Dx457H mm.





# OPERATING INSTRUCTIONS

---

## Setting the Clock

When the microwave oven is powered on, the oven will display "0:00" and the buzzer will ring once.

1. Press **"CLOCK"** once - "00:00" displays.
2. Turn  to adjust the hour figures. The input time should be within 0-23(24-hour).
3. Press **"CLOCK"**. The minute figures will flash.
4. Turn  to adjust the minute figures. The input time should be within 0-59.
5. Press **"CLOCK"** to finish clock setting. ":" will flash.



**Note:** If the clock is not set, it would not function when powered.

Whilst setting the clock, if you press **"STOP/CLEAR"** the oven will go back to the previous status automatically.

## Kitchen Timer



1. Press **"KITCHEN TIMER"** once. The LED display will show "00:00".
2. Turn  to enter the correct timer. (The maximum cooking time is 95 minutes).
3. Press **"START/+30SEC./CONFIRM"** to confirm setting.
4. When the timer has elapsed, the buzzer will ring five times. If the clock has been set, the LED display will show the current time.

## Microwave Cooking

1. Press **"MICROWAVE"**. The LED display will show **"P100"**. Press **"MICROWAVE"** for times, or turn  to choose the power you want. **"P100"**, **"P80"**, **"P50"**, **"P30"** or **"P10"** will display for each added press.
2. Press **"START/+30SEC./CONFIRM"** to confirm.
3. Turn  to set cooking time from 0:05 to 95:00.
4. Press **"START/+30SEC/CONFIRM"** again to start cooking.

## Cooking Example

If you want to use 80% microwave power to cook for 20 minutes, you can operate the oven per the following steps:

- 1) Press **"MICROWAVE"** once. The screen will display **"P100"**.
- 2) Press **"MICROWAVE"** once again or turn  to choose 80% microwave power.
- 3) Press **"Start/+30Sec/Confirm"** to confirm. The screen will display **"P80"**.
- 4) Turn  to adjust the cooking time until the oven displays "20:00".
- 5) Press **"Start/+30Sec/Confirm"** to start cooking.

**Note:** the step quantities for the adjustment time of the coding switch are as follows:

0-1 min	: 5 seconds
1-5 min	:10 seconds
5-10 min	: 30 seconds
10-30 min	: 1 minute
30-95 min	: 5 minutes



## Microwave Power Chart

Press	Once	Twice	Thrice	4 Times	5 Times
Microwave Power	100%	80%	50%	30%	10%

# OPERATING INSTRUCTIONS



---

## Grill or Combi (Grill and Microwave) Cooking

1. Press "**Grill/Combi**". The screen will display "**G**". Press "**Grill/Combi**" for times or turn  to choose the power you want. "**G**", "**C-1**" or "**C-2**" will display for each added press.
2. Press "**START/+30SEC./CONFIRM**" to confirm.
3. Turn  to set cooking time from 0:05 to 95:00.
4. Press "**START/+30SEC./CONFIRM**" again to start cooking.

## Cooking Example

If you want to use 55% microwave power and 45% grill power (C-1) to cook for 10 minutes, you can operate the oven as the following steps.

1. Press "**Grill/Combi**". The screen will display "**G**".
2. Press "**Grill/Combi**" once again or turn  to choose "**C-1**" mode.
3. Press "**START/+30SEC./CONFIRM**" to confirm. The screen will display "**C-1**".
4. Turn  to adjust the cooking time until the oven displays "10:00".
5. Press "**START/+30SEC./CONFIRM**" to start cooking.

## Grill and Microwave Power Chart

Press	Display	Microwave	Grill
Once	G	0%	100%
Twice	C-1	55%	45%
Thrice	C-2	36%	64%

Note: If half the grill time passes, the oven sounds twice, and this is normal.

In order to have a better effect of grilling food, you should turn the food over, close the door, and then press "**START/+30SEC./CONFIRM**".

## Quick start Cooking

1. Whilst the microwave oven is in standby, press "**START/+30SEC./CONFIRM**" key to cook with 100% power level for 30 seconds. Each press on the same key will increase the cooking time by 30 seconds. The maximum cooking time is 95 minutes.
2. During microwave, grill and combination, or time defrost states, press "**START/+30SEC./CONFIRM**" key to cook with 100% power level for 30 seconds. Each press on the same key will increase the time by 30 seconds.

**Note:** this function will not work during defrost and auto menu cooking.

# OPERATING INSTRUCTIONS



---

## Multi-Stage Cooking

A maximum of two stages can be set. If one stage is defrosting, it should be put the first stage. The buzzer will ring once after each stage and the next stage will begin.

**Note:** Auto menu and preheating cannot be set as one of the stages.

**Example:** If you want to defrost the food for 5 minutes, then to cook with 80% microwave power for 7 minutes, the steps are as follows:

1. Press **"Time Defrost"** once. The screen will display **"dEF2"**.
2. Turn  to adjust the defrost time to 5 minutes ("5:00" will be displayed).
3. Press **"MICROWAVE"** once, the screen will display **"P100"**.
4. Turn  to choose 80% microwave power. ("**P80**" will be displayed).
5. Press **"START/+30SEC./CONFIRM"** to confirm.
6. Turn  to adjust the cooking time to 7 minutes. ("7:00" will be displayed).
7. Press **"START/+30SEC./CONFIRM"** to start cooking. Buzzer will sound once for the first section, defrosting time counts down; buzzer will sound once again when entering the second cooking. When cooking finishes, buzzer sounds five times.

## Defrost by Weight

1. Press **"Weight Defrost"**. The LED display will show **"dEF1"**.
2. Turn  to select the weight of food. At the same time, **"g"** will show on the LED display. The weight should be 100-2000g.
3. Press **"START/+30SEC./CONFIRM"** key to start defrosting.

## Defrost by Time

1. Press **"Time Defrost"**. The oven will display **"dEF2"**.
2. Turn  to select the cooking time. The maximum cooking time is 95 minutes.
3. Press **"START/+30SEC./CONFIRM"** key to start defrosting.

## Inquiring Function

1. During cooking, press **"CLOCK/KITCHEN TIMER"** to check the current time. It will be displayed for **3** seconds.
2. During cooking, press **"MICROWAVE"**. The current power will be displayed for **3** seconds.

## Lock-Out Function for Children



**Lock:** In standby mode, hold **"STOP/CLEAR"** for 3 seconds. There will be a long beep which denotes the fact that the oven has entered into the child-lock state. The locked indicator will display if the time has been set, otherwise, screen will display **"[ : : ]"**.

**Unlock:** In locked mode, hold **"STOP/CLEAR"** for 3 seconds. There will be a long beep which denotes the fact that the lock is released.

# OPERATING INSTRUCTIONS

---

## Auto Menu

1. In standby mode, turn  right to choose the function wanted, and "A-1", "A-2", "A-3"...."A-10" will be displayed.
2. Press "**START/+30 SEC/CONFIRM**" to confirm the menu you need.
3. Turn  to choose the weight of menu, and "g" indicator will be displayed.
4. Press "**START/+30 SEC/CONFIRM**" to start cooking.

## Menu Chart

Menu	Weight(g)	Display
A-1 Pizza	200	200
	400	400
A-2 Potato	200	200
	400	400
	600	600
A-3 Meat	250	250
	350	350
	450	450
A-4 Fish	250	250
	350	350
	450	450
A-5 Vegetable	200	200
	300	300
	400	400
A-6 Beverage	1 cup (about 120ml)	1
	2 cup (about 240ml)	2
	3 cup (about 240ml)	3
A-7 Pasta	50g (with 450g cold water)	50
	100g (with 800g cold water)	100
A-8 Popcorn	50	50
	85	85
	100	100
A-9 Chicken	400	400
	800	800
	1200	1200
A-10 Reheat	200	200
	400	400
	600	600

# MAINTENANCE AND CLEANING

---

## CAUTION

### Personal Injury Hazard

It is hazardous for anyone other than a competent person to carry out any service or repair operation that involves the removal of a cover which gives protection against exposure to microwave energy.

## CLEANING

**CAUTION:** Be sure to unplug the appliance from the power supply.

1. Clean the cavity of the oven after use with a damp cloth.
2. Clean accessories in the usual way in soapy water.
3. The door frame and seal and neighbouring parts must be cleaned carefully with a damp cloth when they are dirty.
4. Do not use harsh abrasive cleaners or sharp metal scrapers to clean the oven door glass since they can scratch the surface, which may result in shattering of the glass.

Cleaning Tip - For easier cleaning of the cavity walls that the cooked food can touch:

- Place half a lemon in a bowl. Add 300ml water and heat on 100% microwave power for 10 minutes.
- Wipe the oven clean using a soft, dry cloth.

## TROUBLE SHOOTING

Normal Operation	
Microwave oven interfering with TV reception	Radio and TV reception may be interfered with when the microwave oven is operating. It is similar to the interference of small electrical appliances, such as electric mixers, vacuum cleaners and electric fans. This is normal.
Dim oven light	In low power microwave cooking, the oven light may become dim. This is normal.
Steam accumulating on door, hot air out of vents	Whilst cooking, steam may come out of food. Most of this will dissipate through the vents. Some may accumulate on a cool place like the door. This is normal.
Oven started accidentally with no food in	It is forbidden to run the unit without any food inside. This is very dangerous.

Problem	Possible Cause	Remedy
Oven cannot be started	Power cord not plugged in properly.	Unplug. Plug back in again after 10 seconds.
	Fuse blown or circuit breaker tripped.	Replace fuse or reset circuit breaker.
	Trouble with outlet.	Test outlet with other appliances.
Oven does not heat	Door not closed properly.	Ensure that the door is properly closed.
Glass turntable makes noise when microwave oven operates	Dirty roller rest and oven bottom.	Refer to Maintenance and Cleaning" to clean dirty parts.



## NEW ZEALAND PRODUCT WARRANTY STATEMENT OF STANDARD WARRANTY CONDITIONS

Nothing herein contained shall be construed in any way as excluding or limiting your rights under the Consumer Guarantee Act 1993.

### OUR WARRANTY

This product is also covered by the manufacturer's warranty set out in this document (Our Warranty).

Our Warranty is for a period of forty eight (48) months from the date of purchase.

This is in addition to (and does not exclude, restrict or modify) any rights or remedies to which you may already be entitled to under the New Zealand Consumer Guarantee act 1993 relating to this product.

Our warranty (which is subject to the conditions below) covers rectification free of charge of any fault arising from defective materials or components or faulty workmanship.

The product will be repaired or replaced at the option of Omega.

Our warranty is subject to the following conditions:

1. That the purchaser contacts Omega prior to any product repair.
2. That the purchaser carefully follows all instructions provided with the product and complies with all relevant electrical & plumbing regulations when installing the product.
3. That the purchaser carefully follows the instructions provided in the owner's handbook relating to the proper use and care of the product and does not use the product for any purpose other than the DOMESTIC use for which it has been designed.

### WHAT IS COVERED: By Our Warranty

During the warranty period, Omega or its authorised Service Centre will, at no extra charge, if your appliance is readily accessible without the need of special equipment and subject to the terms and conditions of this warranty, repair or replace any parts which it considers defective.

### WHAT IS NOT COVERED: By Our Warranty

- 1 Products installed damaged or incomplete or not in compliance with the relevant electrical & plumbing regulations in their State.
- 2 Normal wear and tear e.g. cleaning, light globes, filters etc.
- 3 Failure resulting from power surges and electrical storms.
- 4 Insect or vermin infestation.
- 5 Unauthorised repairs or use of non-genuine Omega parts.
- 6 Any failure caused by the product not being used in accordance with the instruction and the installation manual provided with the product.
- 7 Misuse or abuse, including failure to properly maintain or service.
- 8 The clearing of blockages in pumps and hoses.
- 9 Damage which occurs during delivery or installation.
- 10 Claims to product surface coating due to liquid or solid spill-overs, accidental damage or damage caused from cleaning products not recommended by Omega.

### HOW TO CLAIM YOUR WARRANTY

Please refer to our website address below for Omega to register your warranty online.

If you are contacting Omega regarding any warranty claims and spare parts inquiries, please make sure you have the following information on hand:

1. Product Name/Model Number
2. Serial Number/s
3. Purchase Date (as per invoice or proof of purchase)
4. Purchased From
5. Warranty Registration Number

[www.omegaappliances.co.nz](http://www.omegaappliances.co.nz)

Omega is division of Monaco Corporation Limited  
(Member of Shriro Australia PTY LTD)

Phone: (09) 415 6000

Email: [customercare@monacocorp.co.nz](mailto:customercare@monacocorp.co.nz)

