

The Omega logo is displayed in a bold, lowercase, sans-serif font. The letter 'o' is distinguished by a horizontal line passing through its center. The logo is centered horizontally and positioned in the upper half of the page.

omega

Instruction Manual

60CM INDUCTION COOKTOP

OCI604T

Thank you for purchasing an Omega appliance

Tailored for the modern aesthetic and lifestyle of busy people, your new Omega Appliance will make a welcome addition to the family.

Omega caters to style-savvy customers who look for balance between stunning form and clever function. This means a combination of sleek, chic, sophisticated design yet effortless functionality.

We source from the best—superior craftsmanship, cutting-edge innovation, and designs from the world's top international design houses.

All brought together under an appliance that stands for design-led balance.

Please take the time to read through the following instruction manual to familiarise yourself with the installation, operation requirements and maintenance to ensure optimum performance.

Further Information

For important information about your Omega Appliance such as warranty registration, manuals, features, and specifications please visit omegaappliances.co.nz (if you are in New Zealand) or contact our Customer Care team on the below email or phone numbers.

Contact Us

Our customer service team is here to help you with any questions or concerns.

They are on call from Monday to Friday 8.30am to 5.00pm and of course you can always send an email at your convenience.

Email: customercare@monacocorp.co.nz

Phone: 09 415 6000

omega

omegaappliances.co.nz

READ THE INSTRUCTION BOOKLET BEFORE INSTALLING AND USING THE APPLIANCE.

It is important that you retain these instructions, proof of purchase as well as other important documents about this product for future reference.

The manufacturer will not be responsible for any damage to property or to persons caused by incorrect installation or improper use of the appliance.

Due to continual product development, Omega reserves the right to alter specifications and appearances without notice.

Contents

Important Safety Warnings.....	1
Appliance Details	2
Electical Connection.....	2
Installation Instructions.....	3
Operating Instructions	6
Cooking Guidelines	14
Cleaning and Maintenance	15
Troubleshooting.....	16
Transport.....	18
New Zealand Product Warranty Statements of Standard Warranty Conditions.....	19

Disposal Information

- Most of the packaging materials are recyclable. Please dispose of these materials through your local recycling depot or by placing them into appropriate collection containers.
- If you wish to discard this product, please contact your local authorities and ask for the correct method of disposal.

Important Safety Warnings

IMPORTANT: Read the assembly instruction section and safety precautions of this booklet carefully before removing the contents of this carton.

- ⚠ Electrical shock hazard-Do not cook on a broken or cracked cooktop. If the cooktop surface break or crack, switch the appliance off immediately at the mains power supply (wall switch) and contact a qualified technician. Switch the cooktop off at the wall before cleaning or maintenance. Failure to follow this advice may result in electrical shock or death.
- ⚠ Fire- hazard-Unattended cooking on a cooktop with fat or oil can be dangerous and may result in fire. NEVER try to extinguish a fire with water, but switch off the appliance and cover flame, e.g. with a lid or fire blanket. Do not store items on cooking surfaces. Failure to follow this advice may result in serious burns or death.
- ⚠ Health hazard-This appliance complies with electromagnetic safety standards. However, persons with cardiac pacemakers or other electrical implants (such as insulin pumps) must consult with their doctor or implant manufacturer before using this appliance to make sure that their implants will not be affected by the electromagnetic field. Failure to follow this advice may result in death.
- ⚠ Disconnect the appliance from the mains electricity supply before carrying out any work or maintenance on it.
- **Warning**-During use, the appliance and its accessible parts of this appliance will become hot enough to cause burns. Do not let body, clothing or any item other than suitable cookware contact with the ceramic glass until the surface is cool. Never leave metal objects (such as kitchen utensils) or empty pans on the cooktop as they can become hot very quickly.
- No combustible material or products should be placed on this appliance at any time.
- During use the appliances becomes hot. Care should be taken to avoid touching heating elements cooktop.
- Metallic objects such as knives, forks, spoons and lids should not be placed on the cooktop surface since they can get hot.
- Magnetisable metal objects worn on the body may become hot in the vicinity of the cooktop. Gold or silver jewellery will not be affected.
- Cut hazard-Panel edges are sharp, neglecting proper care may result in cuts or injuries.
- The razor-sharp blade of a cooktop scraper becomes exposed when the safety cover is retracted.
- Handles of saucepans may be hot to touch. Check saucepan handles do not overhang other cooking zones that are on.
- Keep handles out of reach of children. Failure to follow this advice could result in burns and scalds.
- Never leave the appliance unattended when in use. Boil over causes smoking and greasy spillovers that may ignite.
- Never use your appliance as a work or storage surface.
- Never leave any objects or utensils on the appliance.
- Do not place or leave any magnetisable objects (e.g. credit cards, memory cards) or electronic devices (e.g. computers, MP3 players) near the appliance, as they may be affected by its electromagnetic field.
- We recommend using plastic or wooden kitchen utensils for cooking with your induction cooktop.
- Never use your appliance for warming or heating the room.
- After use, always turn off the cooking zones and the cooktop as described in this manual (by using the touch controls). Do not rely on the pan detection feature to turn off the cooking zones when you remove the pans.
- Do not allow children to play with the appliance or sit, stand, or climb on it.
- Do not store items of interest to children in cabinets above the appliance. Children climbing on the cooktop could be seriously injured.
- Do not leave children alone or unattended in the area where the appliance is in use.
- Children of less than 8 years old must be kept away from the appliance unless continuously supervised. This appliance can be used by children aged from 8 years and above, and persons with reduced physical, sensory or mental capabilities or lack of experience and knowledge, if they have been given supervision or instruction concerning the use of the appliance in a safe way and they understand the hazards involved. Cleaning and user maintenance shall not be done by children without supervision.
- Do not repair or replace any part of the appliance unless specifically recommended in the manual. All other servicing should be done by a qualified technician.
- Do not use a steam cleaner to clean your cooktop.
- **CAUTION:** The cooking process has to be supervised. A short term cooking process has to be supervised continuously.
- Do not place or drop heavy objects on your cooktop.
- Do not stand on your cooktop.
- Do not use pans with jagged edges or drag pans across the ceramic glass surface as this can scratch the glass.
- Do not use scourers or any other harsh/abrasive cleaning agents to clean your cooktop, as these can scratch the ceramic glass.
- If the power supply cable is damaged, it must only be replaced by a qualified technician.
- Do not operate your cooktop by means of an external timer or separate remote-control system.
- This appliance is intended to be used in a domestic household environment only!

Appliance Details

Electrical Details

Model	OCI604T
Voltage Rating	220-240V~ 50Hz
Power Rating	7200W
Cooking Zones	4
Product Dimension L × W × H(mm)	590x520x62mm
Cut-out Dimension W × D(mm)	560x490mm

Electical Connection

LOCAL AUTHORITY REQUIREMENTS



Installation is only permitted by a licensed electrician and carried out according to instructions provided by the manufacturer. Incorrect installation might cause harm and damage which the manufacturer accepts no responsibility.

ELECTRICAL INSTALLATION FOR THE LICENSED ELECTRICIAN

- This cooktop must be connected to a 220-240V 50Hz power supply. It is earthed via the wire.
- Before carrying out the connection to the power supply, the voltage rating of the appliance must be checked for correspondence to the available mains supply voltage, and the mains electric wiring should be suitable for the cooktop's power rating (also indicated on the appliance identification plate).
- This appliance should be connected to a circuit which incorporates an isolating switch providing full disconnection from the power supply.
- The switched outlet must be connected to a suitable earth wiring, in conformity to current safety regulations.
- After having installed the appliance, the switched outlet must always be in an accessible position.
- NOTE: For connections to the mains power supply, never use adapters, reductions or multiple power points as these may overheat and catch fire.
- The mains terminal block is located on the back of the cooktop and the terminals are accessible by opening the terminal block cover. Note: The terminal cover should not be opened when the mains power is still connected to the appliance and never by an unauthorized person.
- The isolating switch must be of an approved type, offering a 3 mm air gap contact separation in all poles.
- The cable must not be bent or compressed.
- The electrical safety of this appliance can only be guaranteed if the cooktop is correctly and efficiently earthed. The manufacturer declines all responsibility for damage resulting from an installation which has not been earthed correctly.
- The use of adapters, multiple sockets and/or extensions is not allowed.
- This appliance incorporates an earth connection for functional purposes.

Installation Instructions

- Cut out the benchtop according to the sizes shown in the drawing.
- To ensure proper installation and operation, a minimum of 50mm space shall be maintained around the cut out.
- Ensure the kitchen benchtop material is heat-resistant to prevent excessive deformation caused by the heat from the cooktop, as shown below:

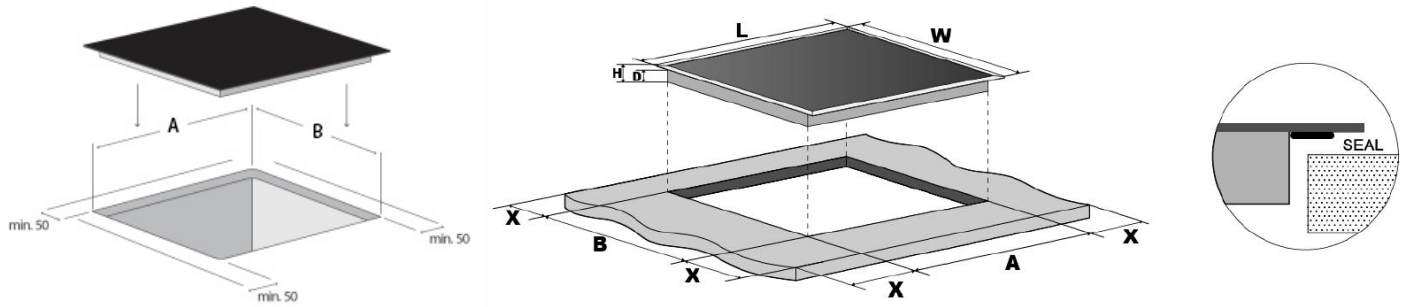

L(mm)	W(mm)	H(mm)	D(mm)	A(mm)	B(mm)	X(mm)
590	520	62	58	560	490	50(min)

Under no circumstances should the cooktop be obstructed, and it must be well-ventilated with both air inlet and outlet unobstructed. Ensure the cooktop is in proper working condition as shown below.

Note: The safety distance between the cooktop and the cupboard above the cooktop should be at least 600mm.

A(mm)	600-750
B(mm)	50(min)
C(mm)	20(min)
D(mm)	Air inlet
E(mm)	Air outlet

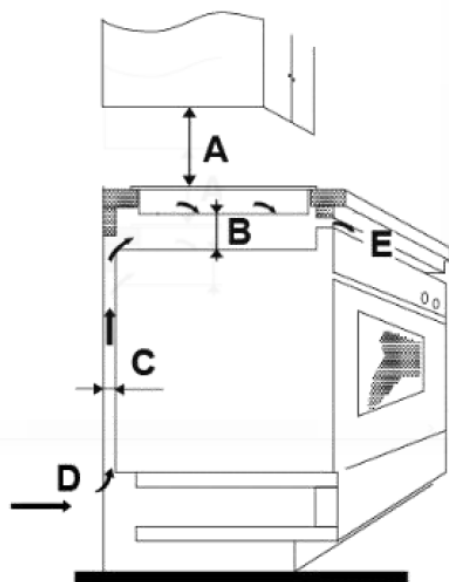

Installation Instructions

Before installing the cooktop, ensure the following:

- The benchtop is level and square, with no structural elements obstructing the required space.
- The benchtop is made of a heat-resistant material.
- If the cooktop is installed above an oven, the oven must have a built-in cooling fan.
- The installation complies with all clearance requirements and relevant standards and regulations.
- A suitable isolating switch is incorporated into the permanent wiring, providing full disconnection from the mains power supply. The switch must be mounted and positioned in accordance with local wiring rules and regulations.
- The isolating switch is easily accessible once the cooktop is installed.
- If in doubt regarding installation, consult local building authorities and by-laws.
- Heat-resistant and easy-to-clean finishes (such as ceramic tiles) are used for the wall surfaces surrounding the cooktop.

After installing the cooktop, ensure the following:

- The power supply cable is not accessible through cabinetry.
- There is adequate airflow from outside the cabinetry to the base of the cooktop.
- If the cooktop is installed above a drawer or cupboard, a thermal protection barrier is installed below the base of the cooktop.

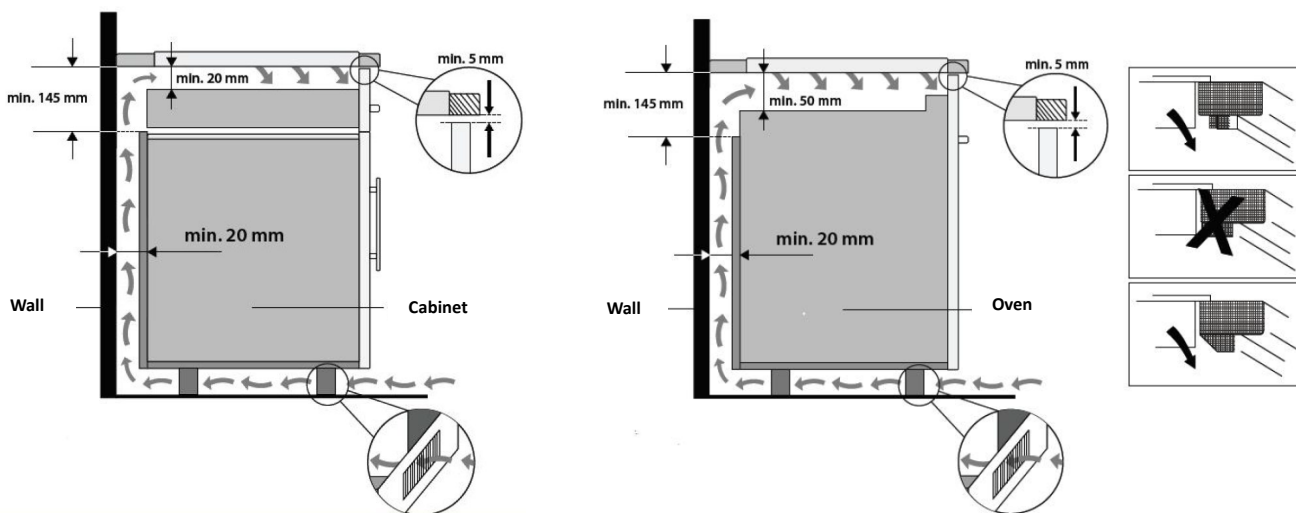

Installation Instructions

Locating the fixing brackets

Place the cooktop on a stable, smooth surface. Do not apply force to the controls protruding from the cooktop. Secure the cooktop to the benchtop by attaching four fixing brackets to the bottom of the cooktop with screws (refer to the illustration below). Adjust the position of the fixing brackets to accommodate different benchtop thicknesses as needed.

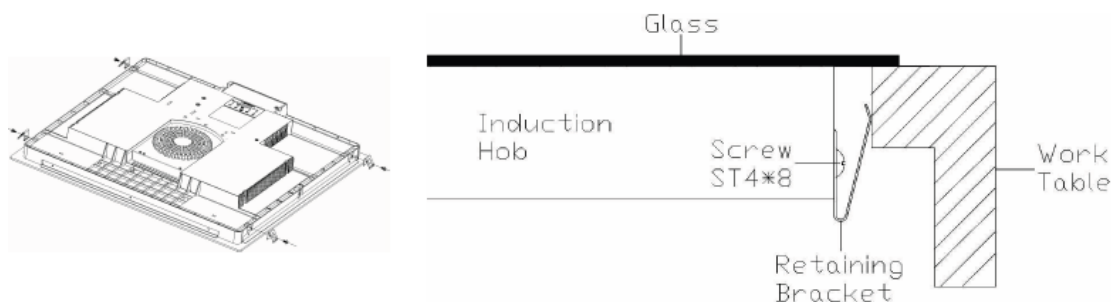

- The cooktop must be installed by qualified personnel or technicians. Please do not attempt to install it by yourself.
- The cooktop must not be mounted on cooling equipment, dishwashers, or rotary dryers.
- The cooktop must be installed in a manner that allows adequate heat dissipation to enhance reliability.
- The wall and any surfaces above the work area must be heat-resistant.
- To prevent damage, the sandwich layer and adhesive materials used in the installation must be heat-resistant.

Operating Instructions

Product information

The induction cooktop is a modern cooking appliance that offers significant advantages over traditional cooktops, such as easy cleaning, high efficiency, eco-friendliness, and improved safety features. Induction cooking is a safe, advanced, efficient, and economical technology. It works by generating heat directly to the pan through electromagnetic vibrations, rather than heating the glass surface indirectly. The glass only becomes hot when the pan transfers heat to it.

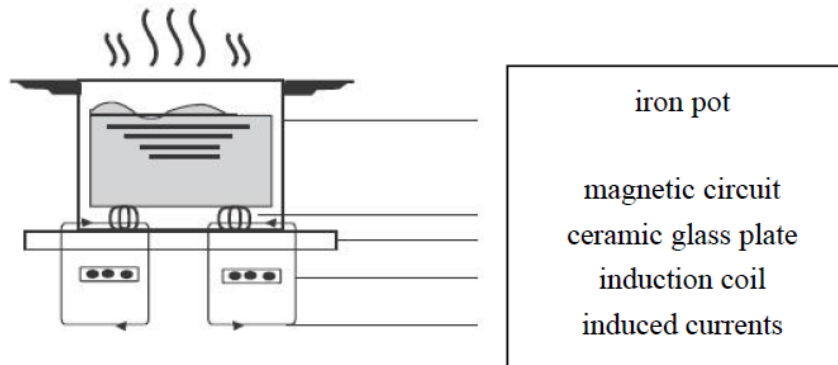

Touch controls

- The controls are touch-sensitive, so no pressure is required.
- Use the pulp of your finger rather than the tip for better accuracy.
- A beep will sound each time a touch is successfully registered.
- Ensure the controls are always clean, dry, and free of obstructions (e.g., utensils or cloths). Even a thin layer of water can affect their responsiveness.



Choosing the compatible cookware: ferromagnetic cookware is compatible with induction cooking. Look for the induction symbol  on the packaging or the bottom of the pan.

- **Magnet test:** You can also test your cookware by using a magnet. Move the magnet towards the base of the pan. If it is attracted, the pan is suitable for induction.



Operating Instructions

- **Alternative test** (no magnet):
 - Add some water to the pan you want to check.
 - Follow the instructions under “To start cooking”.
 - If ‘**B**’ does not flash on the display and the water heats up, the pan is suitable for induction.

Avoid the incompatible cookware: the following materials are not compatible with induction cooking: pure stainless steel, aluminium or copper without a magnetic base, glass, wood, porcelain, ceramic, and earthenware.

- Do not use cookware with a partially ferromagnetic base, as only the ferromagnetic area will be heated, resulting in uneven heat distribution. The non-ferromagnetic area may not reach the necessary temperature for cooking.
- Do not use cookware with a base that is made from materials containing aluminium, the ferromagnetic area will be reduced. This may result in the cookware not reaching a sufficient temperature or, in some cases, not being detected at all.

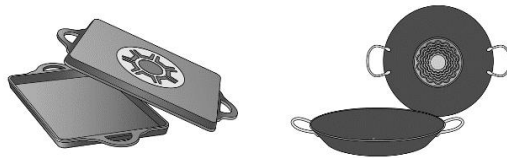

- The material of the cookware base can affect the cooking performance. Using pots and pans made from materials that distribute heat evenly, such as stainless-steel pans with a three-layer base, helps save time and energy. Always use cookware with a flat base, as uneven bases may hinder proper heat distribution.
- Do not use cookware with jagged edges or a rounded base.



- Ensure the base of your pan is smooth, flat against the glass, and matches the size of the cooking zone. Always position your pan at the centre of the cooking zone.

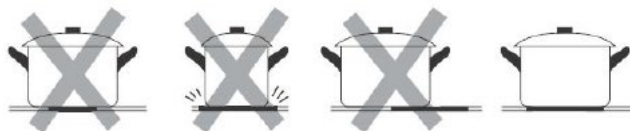

- Always lift pans off the cooktop; do not slide them, as this may scratch the glass.

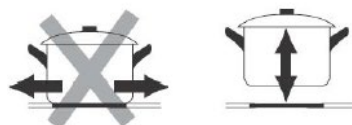

Operating Instructions

Top view

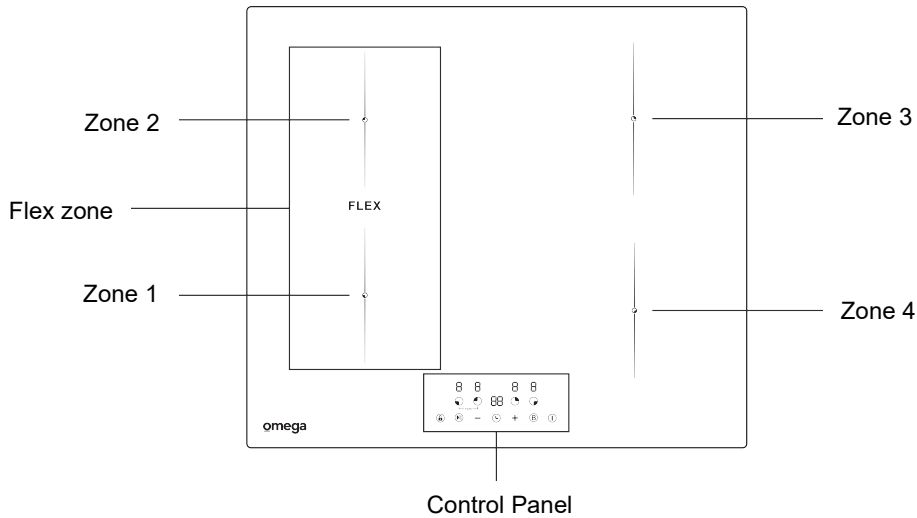

Zone 2:	1800-2200W, Ø190mm	Zone 3:	1800-2200W, Ø180mm
Zone 1:	1800-2200W, Ø190mm	Zone 4:	1200-1500W, Ø160mm
Flex Zone:	(Zone 1+Zone2), 3000-3500W, Ø380x190mm		

Control panel

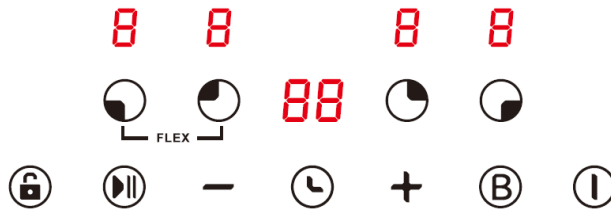

88	Timer indicator/Minute display
8	Power level indicator
	Timer control
-	Power level or timer adjusting control
+	Power level or timer adjusting control
	Cooking zone selection controls
	Touch together to select flex zone
	Child lock control
	Boost control
	ON/OFF control
	Pause control

Operating Instructions

To start cooking

1. After powering on, the buzzer will sound once, and all indicators will light up for 1 second before turning off, indicating that the cooktop is in standby mode.
2. Touch the ON/OFF control “**I**” and all indicators will display “-”.
3. Place a suitable pan on the desired cooking zone. Ensure that both the bottom of the pan and the surface of the cooking zone are clean and dry.
4. Touch the corresponding cooking zone selection control “”. The indicator next to the cooking zone selection control will flash.
5. Adjust the power level by touching the button “+” or “-”.

Note:

- If no heat setting is selected within 1 minute, the cooktop will automatically turn off. You will need to start again from step 1.
- You can adjust the heat setting at any time during cooking.

When finish cooking:

1. Select the cooking zone selection control you wish to turn off by touching the corresponding control.
2. Turn off the cooking zone by holding the control until the power level drops to “0”. Ensure the display shows “0”.
3. Turn off the entire cooktop by touching the ON/OFF control.

Caution: Hot surfaces

The “H” symbol will appear to the corresponding cooking zone that is still hot. It will disappear once the surface has cooled down to a safe temperature. You can also use this feature as an energy-saving function. If you wish to heat additional pans, you can use the cooking zone that is still hot.

Boost function

Activate the boost function

1. Select the cooking zone you want to boost.
2. Touch the boost control “**B**”. The power level display will show “P.”

Cancel the boost function

1. Select the cooking zone currently in boost mode.
2. Touch the power adjustment control to deactivate the boost mode and set the desired power level.

Note:

The boost function lasts for a maximum of 5 minutes. After this time, the cooking zone will automatically revert to power level 9.

Child lock function

You can lock the controls to prevent unintended use, such as children accidentally turn on the cooking zones. When the controls are locked, all functions are disabled except for the ON/OFF control.

Operating Instructions

To lock the controls

1. Touch the child lock control “”.
2. The timer indicator will display “Lo.”

To unlock the controls

1. Touch and hold the child lock control for a few seconds.
2. Once unlocked, you can start using your cooktop again.

Important note:

While in lock mode, all controls are disabled except the ON/OFF switch. In an emergency, you can always turn off the cooktop using the ON/OFF switch. However, you will need to unlock the cooktop before using it again.

Residual heat warning

After the cooktop has been in use for a while, residual heat may remain. The letter "H" will appear on the display as a warning to avoid contact with the hot surface.

Auto shutdown

The cooktop is equipped with an auto shutdown safety feature. This function activates when a cooking zone is left on for an extended period without being switched off. The default shutdown times are listed in the table below:

Power Level	1	2	3	4	5	6	7	8	9
Default Working Times (hour)	8	8	8	4	4	4	2	2	2

Using the timer

The timer offers two modes of operations: **minute minder mode** and **auto-off mode**.

Note: The timer can be set for a maximum of 99 minutes.

a) Minute minder mode: the timer will alert you when the set time expires. It will not turn off any cooking zones.

1. Ensure the cooktop is turned on.

Note: You can use the minute minder either before or after setting the cooking zone.

2. Touch the timer control, and “30” will appear on the timer display, with the “0” flashing.



Operating Instructions

3. Set the time by touching the “-” or “+” control on the timer (e.g., to 5 minutes). Long touch the control to adjust the time by 10 minutes.

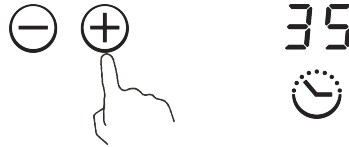

4. Once the time is set, the countdown will begin immediately, and the remaining time will be displayed.
5. The buzzer will beep for 20 seconds, and the timer indicator will show “- -” when the set time has finished.

b) Auto-off mode, set the timer to turn off one or multiple cooking zones automatically. Once the set time is reached, it will turn off one or multiple cooking zones.

Timer for one zone:

1. Touch the heating zone selection control for the zone you wish to set the timer for.
2. Touch the timer control, and "30" will appear on the timer display, with the "0" flashing.



3. Set the time by touching the “-” or “+” control on the timer (e.g., to 5 minutes). Long touch the control to adjust the time by 10 minutes.



4. Once the time is set, the countdown will begin immediately, and the remaining time will be displayed.

Note: The red dot next to the power level indicator will illuminate, indicating that the zone is selected.



5. When the cooking timer expires, the corresponding cooking zone will turn off automatically. Other cooking zones will continue operating if they were previously turned on.

Operating Instructions

Timer for multiple zones:

1. When you set the timer for multiple cooking zones simultaneously, the decimal dots of the relevant zones will illuminate. The minute display will show the shortest timer duration, and the red dot of the corresponding zone will flash.



2. Once the countdown timer expires, the corresponding zone will turn off automatically. The display will then show the new minimum timer, and the dot of the corresponding zone will flash.

Note: Touch the heating zone selection control, and the corresponding timer will be displayed in the timer indicator.

Canceling the timer

1. Touch the heating zone selection control for the zone you want to cancel the timer.



2. Touch the timer control, and the indicator will flash.



3. Touch the "-" control to set the timer to "00," and the timer will be cancelled.

Using the pause function

1. Select the pause control "⏸", and all heating zones will stop working. The indicator for each zone will display "||".
2. Touch the pause control again, and all heating zones will revert to their original settings.

Note:

- The function is available when one or more heating zones are in use.
- If you do not cancel the pause mode within 30 minutes, the induction cooktop will switch off automatically.

Operating Instructions

Heat settings

Power Level	Applications
1 - 2	<ul style="list-style-type: none">•Delicate warming for small amounts of food•Melting chocolate, butter, and foods that burn quickly•Gentle simmering•Slow warming
3 - 4	<ul style="list-style-type: none">• Reheating• Rapid simmering• Cooking rice
5 - 6	<ul style="list-style-type: none">• Cooking pancakes
7 - 8	<ul style="list-style-type: none">• Sautéing• Cooking pasta
9	<ul style="list-style-type: none">• Stir-frying• Searing• Bringing soup to the boil• Boiling water

Cooking Guidelines

Important safety tip:

Be cautious when frying, as oil and fat heat up very quickly, especially when using power boost function. At extremely high temperatures, oil and fat can ignite spontaneously, presenting a serious fire risk.

Cooking tips:

- When food reaches a boil, reduce the power setting.
- Using a lid to help reducing cooking times and saving energy by trapping heat.
- Minimize the amount of liquid or fat to shorten cooking time.
- Start cooking at a high setting, then reduce the setting once the food is heated through.

Simmering and cooking rice:

Simmering occurs below boiling point, at around 85°C, when bubbles occasionally rise to the surface of the cooking liquid. This is key for making delicious soups and tender stews, allowing flavours to develop without overcooking the food. Egg-based and flour-thickened sauces should also be cooked below boiling point. Some tasks, such as cooking rice using the absorption method, may require a setting higher than the lowest setting to ensure proper cooking within the recommended time.

Searing steak:

To cook juicy, flavourful steaks:

1. Let the meat sit at room temperature for about 20 minutes before cooking.
2. Heat a heavy-based frying pan.
3. Brush both sides of the steak with oil. Drizzle a small amount of oil into the hot pan, then place the steak in the pan.
4. Turn the steak only once during cooking. The cooking time depends on the thickness of the steak and your preferred level of doneness. Times may range from 2–8 minutes per side. Press the steak to gauge its doneness—the firmer it feels, the more "well done" it will be.
5. Let the steak rest on a warm plate for a few minutes before serving, allowing it to relax and become tender.

For stir-frying:

1. Use a ceramic-compatible flat-based wok or large frying pan.
2. Have all ingredients and equipment ready. Stir-frying should be quick. For large quantities, cook the food in smaller batches.
3. Briefly preheat the pan and add two tablespoons of oil.
4. Cook the meat first, set it aside, and keep it warm.
5. Stir-fry the vegetables. When they are hot but still crisp, lower the cooking zone setting, return the meat to the pan, and add your sauce.
6. Stir the ingredients gently to ensure even heating.
7. Serve immediately.

Cleaning and Maintenance



WARNING: Switch off the appliance and allow it to cool before cleaning is to be carried out.

Problems	How to do	Important notes
<p>Everyday soiling on glass (Fingerprints, marks, stains left by food or non-sugary spillovers on the glass)</p>	<ul style="list-style-type: none"> • Switch off the power to the cooktop. • Apply a cooktop cleaner while the glass is still warm (but not hot!). • Rinse and wipe dry with a clean cloth or paper towel. • Switch the power to the cooktop back on. 	<ul style="list-style-type: none"> • When the power is switched off, there will be no “hot surface” indication, but the cooking zone may still be hot! Take extreme care. • Avoid using heavy-duty scourers, some nylon scourers, and harsh or abrasive cleaning agents, as they may scratch the glass. Always check the label to ensure your cleaner or scourer is suitable. • Never leave cleaning residue on the cooktop, as this can cause the glass to become stained.
<p>Boilovers, melts, and hot sugary spills on the glass</p>	<ul style="list-style-type: none"> • Switch off the power to the cooktop. • Hold the blade or utensil at a 30° angle and scrape the spill or soiling toward a cool area of the cooktop. • Wipe up the spill using a dishcloth or paper towel. • Follow steps for everyday soiling above. 	<ul style="list-style-type: none"> • Stains from melts and sugary spills should be removed as soon as possible. If left to cool, they can become difficult to remove or may even cause permanent damage to the glass surface. • Cut hazard: when the safety cover is retracted, the blade on a scraper is razor-sharp. Use with extreme care and store it safely, out of reach of children.
<p>Spillovers on the touch controls</p>	<ul style="list-style-type: none"> • Switch off the power to the cooktop. • Soak up the spill with a clean cloth or sponge. • Wipe the touch control area with a damp sponge or cloth. • Dry the area completely using a paper towel. • Switch the power to the cooktop back on. 	<ul style="list-style-type: none"> • If there is liquid on the touch controls, the cooktop may beep, turn itself off, or the controls may not function. • Ensure the touch control area is completely dry before turning the cooktop back on.

Troubleshooting

If you still have a problem with your appliance after checking these basic troubleshooting steps, please contact an authorised service person or qualified technician.

Problem	Possible Causes	Solutions
The cooktop cannot be turned on.	<ul style="list-style-type: none"> No power 	<ul style="list-style-type: none"> Ensure the cooktop is properly connected to the power supply and switched on. Check if there is a power outage in your home or area. If the problem persists after performing these checks, contact a qualified technician for assistance.
The touch controls are unresponsive.	<ul style="list-style-type: none"> The controls are locked. 	<ul style="list-style-type: none"> Unlock the controls. Refer to the "child lock function" section in this manual for detailed instructions.
The touch controls are difficult to operate.	<ul style="list-style-type: none"> A slight film of water may be covering the controls. You might be using your finger tip instead of the finger pulp. 	<ul style="list-style-type: none"> Ensure the touch control area is completely dry. Use the ball of your finger rather than the tip when operating the controls.
The glass is being scratched.	<ul style="list-style-type: none"> Rough-edged cookware is being used. Abrasive scourers or unsuitable cleaning products are damaging the surface. 	<ul style="list-style-type: none"> Use cookware with flat, smooth bases. Refer to the section "Choosing the Right Cookware" for guidance. Avoid abrasive scourers or cleaning products. Refer to "cleaning and maintenance" for proper maintenance instructions.
Some pans make crackling or clicking noises.	<ul style="list-style-type: none"> The sound is caused by the construction of cookware, as layers of different metals may vibrate differently. 	<ul style="list-style-type: none"> This is a normal with certain types of cookware and does not indicate any fault with the cooktop.
The induction cooktop makes a low humming noise when used on a high heat setting.	<ul style="list-style-type: none"> This sound is a result of the technology used in induction cooking. 	<ul style="list-style-type: none"> This is normal. The noise should reduce or stop entirely when you lower the heat setting.
Fan noise coming from the induction cooktop.	<ul style="list-style-type: none"> A built-in cooling fan has activated to prevent the electronics from overheating. 	<ul style="list-style-type: none"> This is normal. The fan may continue to run even after the induction cooktop is turned off. No action is needed. Do not switch off the power at the wall while the fan is still running.

Troubleshooting

Problem	Possible Causes	Solutions
Pans do not become hot and appears in the display.	<ul style="list-style-type: none"> • The induction cooktop cannot detect the pan because it is not suitable for induction cooking. • The pan may be too small for the cooking zone or not properly centred on it. 	<ul style="list-style-type: none"> • Use cookware that is suitable for induction cooking. See the section “Choosing the right cookware” for more details. • Ensure the pan is centred and that its base is the correct size for the cooking zone.
The cooktop or a cooking zone has turned itself off unexpectedly, a beep sounds, and an error code is displayed.	<ul style="list-style-type: none"> • A technical fault has occurred. 	<ul style="list-style-type: none"> • Note down the error code (letters and numbers displayed). • Switch off the power to the induction cooktop. • Contact a qualified technician for further assistance.

Error code

Code	Possible Causes	Solutions
E3/E7	Temperature sensor failure	Please contact the supplier.
E5	Overheat protection of ceramic glass	Please re-connect the power supply and turn on the cooktop after 30min.
E4/E6	Temperature sensor of the IGBT failure	Please contact the supplier.
E1/E2	Abnormal supply voltage	Inspect whether the power supply is normal. Power on the cooktop after the power supply is normal.
Er	PCBA failure	Please contact the supplier.
Et	Overflow protection	Dry the surface water and restart.

The above are the judgments and inspections for common failures.

Important: Please **do not disassemble** the unit by yourself to avoid potential dangers and damage to the induction cooktop.

Transport

If you need to transport the product, use the original product packaging and carry it using its original case. Follow the transport signs on the packaging. Tape all independent parts to the product to prevent damaging the product during transport.

If you do not have the original packaging, prepare a carriage box so that the appliance, especially the external surfaces of the product, is protected against external threats.

New Zealand Product Warranty Statements of Standard Warranty Conditions

New Zealand Customers

Nothing herein contained shall be construed in any way as excluding or limiting your rights under the Consumer Guarantee Act 1993.

Our Warranty

This product is also covered by the manufacturer's warranty set out in this document (Our Warranty).

Our Warranty is for a period of forty-eight (48) months from the date of purchase. This is in addition to (and does not exclude, restrict or modify) any rights or remedies to which you may already be entitled under the New Zealand Consumer Guarantee Act 1993 relating to this product. Our Warranty (which is subject to the conditions below) covers rectification free of charge of any fault arising from defective materials or components, or faulty workmanship. The product will be repaired or replaced at the option of Omega, and all costs of installation, removal, cartage, freight travelling expenses and insurance are to be paid by the customer.

Our Warranty is subject to the following conditions:

1. That the purchaser contact Omega prior to any product repair.
2. That the purchaser carefully follows all instructions provided with the product and complies with all relevant electrical & plumbing regulations in their State when installing the product.
3. That the purchaser carefully follows the instructions provided in the owner's handbook relating to the proper use and care of the product and does not use the product for any purpose other than the DOMESTIC use for which it has been designed. If the appliance is used in commercial applications or for rental purposes, Our Warranty is limited to a warranty of Twelve (12) months covering all parts with Three (3) months on any labour cost of service or repair.

Service Area

The provision of service under Our Warranty is limited by the boundary / territory area of the nearest service centre. Travelling cost incurred for service outside this area is not covered by Our Warranty

and service will incur commercial cost to be paid by the customer regulated by the number of kilometres travelled beyond the service area. These costs will be disclosed to you for acceptance by you prior to your claim being processed. Microwave ovens must be returned to your nearest Authorised Service Centre for repair as they are a carry in serviceable appliance.

What is Covered by our Warranty

During the warranty period, Omega or its authorised Service Centre will, at no extra charge, if your appliance is readily accessible without the need of special equipment and subject to the terms and conditions of this warranty, repair or replace any parts which it considers defective.

What is not Covered by our Warranty

1. Products installed damaged or incomplete or not in compliance with the relevant electrical & plumbing regulations in their State.
2. Normal wear and tear eg. cleaning, light globes, filters etc.
3. Failure resulting from power surges and electrical storms.
4. Insect or vermin infestation.
5. Unauthorised repairs or use of non-genuine Omega parts.
6. Any failure caused by the product not being used in accordance with the instruction and the installation manual provided with the product.
7. Misuse or abuse, including failure to properly maintain or service.
8. The clearing of blockages in pumps and hoses.
9. Damage which occurs during delivery or installation.
10. Claims to product surface coating due to liquid or solid spillovers, accidental damage or damage caused from cleaning products not recommended by Omega.

How to Claim Our Warranty

To make a claim under Warranty you will need to contact Omega in New Zealand by using the contact details below. If you are contacting Omega regarding any warranty claims and spare parts inquiries, please make sure you have the following information on hand:

1. Product Name/Model Number
2. Serial Number/s
3. Purchase Date (as per invoice or proof of purchase)
4. Purchased From
5. Warranty Registration Number (if registered)

Contact Us New Zealand

Omega is a division of Monaco Corporation (member of Shriro)

Phone: 09 415 6000

Email: customercare@monacocorp.co.nz



omega

omegaappliances.co.nz